



# OPERATING MANUAL

RAZORCUT

40PCI

**3** YEAR  
PRODUCT  
WARRANTY



**40 AMP PLASMA CUTTER WITH INTERNAL AIR  
COMPRESSOR**

SKU:RC40PCi









**RAZORCUT<sup>®</sup>**

# CONTENTS

SAFETY.....	4
TECHNICAL DATA.....	7
MACHINE LAYOUT.....	8
WHAT'S IN THE BOX.....	10
GENERAL OPERATING TIPS.....	11
SETUP FOR INTERNAL AIR PLASMA CUTTING.....	12
SETUP FOR EXTERNAL AIR PLASMA CUTTING.....	15
PLASMA CUTTING TECHNOLOGY.....	19
PLASMA CUTTING TIPS & TECHNIQUES.....	20
TORCH BREAKDOWN & SPARES.....	22
MACHINE PARTS BREAKDOWN.....	23
FAQ & TROUBLESHOOTING.....	24

## Thank you for your purchase of your RAZORWELD Welding/Cutting Machine.

We are proud of our range of welding equipment that has a proven track record of innovation, performance and reliability. Our product range represents the latest developments in Inverter technology put together by our professional team of highly skilled engineers. The expertise gained from our long involvement with inverter technology has proven to be invaluable towards the evolution and future development of our equipment range. This experience gives us the inside knowledge on what the arc characteristics, performance and interface between man and machine should be. Within our team are specialist welders that have a proven history of welding knowledge and expertise, giving vital input towards ensuring that our machines deliver control and performance to the utmost professional level. We employ an expert team of professional sales, marketing and technical personnel that provide us with market trends, market feedback and customer comments and requirements. Secondly they provide a customer support service that is second to none, thus ensuring our customers have confidence that they will be well satisfied both now and in the future.

RAZORWELD welders are manufactured and compliant with - CAN/CSA E60974-1 & ANSI/IEC 60974-1, guaranteeing you electrical safety and performance.



## California Proposition 65

**WARNING:** This product contains or produces a chemical known to the State of California to cause cancer and birth defects (or other reproductive harm) (California Health and Safety Code Section 25249.5 et seq.)

**WARNING:** This product, when used for welding or cutting, produces fumes or gases which contain chemicals known to the State of California to cause birth defects and, in some cases, cancer (California Health and Safety Code Section 25249.5 et seq.).

### INFORMATION SOURCES

- California Health and Safety Code, Section 25249.4 through 25249.13.
- The California Office of Environmental Health Hazard Assessment, 301 Capitol Mall, Sacramento, CA 95814; telephone 916-445-6900.
- California Proposition 65 website: [www.oehha.ca.gov/prop65.html](http://www.oehha.ca.gov/prop65.html).
- American National Standards Institute (ANSI). Product Safety Signs And Labels (ANSI Z535.4), available from ANSI, 25 West 43rd Street, New York, NY 10036; telephone: 212-642-4900; web site: [www.ansi.org](http://www.ansi.org).

## WARRANTY

- 3 Years from date of purchase.
- JASIC Technologies America Inc Ltd warranties all goods as specified by the manufacturer of those goods.
- This Warranty does not cover freight or goods that have been interfered with.
- All goods in question must be repaired by an authorised repair agent as appointed by this company.
- Warranty does not cover abuse, mis-use, accident, theft, general wear and tear.
- New product will not be supplied unless JASIC Technologies America Inc has inspected product returned for warranty and agree to replace product.
- Product will only be replaced if repair is not possible
- Please view full Warranty term and conditions supplied with machine or at [www.razorweld.com](http://www.razorweld.com) or at the back of this manual.

# SAFETY

**Welding and cutting equipment can be dangerous to both the operator and people in or near the surrounding working area if the equipment is not correctly operated. Equipment must only be used under the strict and comprehensive observance of all relevant safety regulations.**

**Read and understand this instruction manual carefully before the installation and operation of this equipment.**

## **WARNING: USE COMPRESSED AIR ONLY WITH THIS MACHINE**

### **Machine Operating Safety**

- Do not switch the function modes while the machine is operating. Switching of the function modes during welding can damage the machine. Damage caused in this manner will not be covered under warranty.
- Disconnect the electrode-holder cable from the machine before switching on the machine, to avoid arcing should the electrode be in contact with the workpiece.
- Operators should be trained and or qualified.



**Electric shock: It can kill.** Touching live electrical parts can cause fatal shocks or severe burns. The electrode and work circuit is electrically live whenever the output is on. The input power circuit and internal machine circuits are also live when power is on. In MIG/MAG welding, the wire, drive rollers, wire feed housing, and all metal parts touching the welding wire are electrically live. Incorrectly installed or improperly grounded equipment is dangerous.

- Connect the primary input cable, according to North American Standards.
- Avoid all contact with live electrical parts of the welding/cutting circuit, electrodes and wires with bare hands.
- The operator must wear dry welding gloves while he/she performs the welding/cutting task.
- The operator should keep the workpiece insulated from himself/herself.
- Keep cords dry, free of oil and grease, and protected from hot metal and sparks.
- Frequently inspect input power cable for wear and tear, replace the cable immediately if damaged, bare wiring is dangerous and can kill.
- Do not use damaged, undersized, or badly joined cables.
- Do not drape cables over your body.



**Fumes and gases are dangerous.** Smoke and gas generated while welding or cutting can be harmful to people's health. Welding produces fumes and gases. Breathing these fumes and gases can be hazardous to your health.

- Do not breathe the smoke and gas generated while welding or cutting, keep your head out of the fumes.
- Keep the working area well ventilated, use fume extraction or ventilation to remove welding/cutting fumes and gases.
- In confined or heavy fume environments always wear an approved air-supplied respirator.
- Welding/cutting fumes and gases can displace air and lower the oxygen level, causing injury or death. Be sure the breathing air is safe.
- Do not weld/cut in locations near degreasing, cleaning, or spraying operations. The heat and rays of the arc can react with vapours to form highly toxic and irritating gases.
- Materials such as galvanised, lead, or cadmium plated steel, containing elements that can give off toxic fumes when welded/cut. Do not weld/cut these materials unless the area is very well ventilated, and or wearing an air-supplied respirator.



**Arc rays: harmful to people's eyes and skin.** Arc rays from the welding/cutting process produce intense visible and invisible ultraviolet and infrared rays that can burn eyes and skin.

- Always wear a welding helmet with the correct shade of filter lens and suitable protective clothing, including welding gloves while the welding/cutting operation is performed.
- Measures should be taken to protect people in or near the surrounding working area. Use protective screens or barriers to protect others from flash, glare and sparks; warn others not to watch the arc.



**Fire hazard.** Welding/cutting on closed containers, such as tanks, drums, or pipes, can cause them to explode. Flying sparks from the welding/cutting arc, hot workpiece, and hot equipment can cause fires and burns. Accidental contact of the electrode to metal objects can cause sparks, explosion, overheating, or fire. Check and be sure the area is safe before doing any welding/cutting.

- The welding/cutting sparks & spatter may cause fire, therefore remove any flammable materials well away from the working area. Cover flammable materials and containers with approved covers if unable to be moved from the welding/cutting area.
- Do not weld/cut on closed containers such as tanks, drums, or pipes, unless they are correctly prepared according to the required Safety Standards to ensure that flammable or toxic vapours and substances are totally removed, these can cause an explosion even though the vessel has been “cleaned”. Vent hollow castings or containers before heating, cutting or welding. They may explode.
- Do not weld/cut where the atmosphere may contain flammable dust, gas, or liquid vapours (such as petrol)
- Have a fire extinguisher nearby and know how to use it. Be alert that welding/cutting sparks and hot materials from welding/cutting can easily go through small cracks and openings to adjacent areas. Be aware that welding/cutting on a ceiling, floor, bulkhead, or partition can cause a fire on the hidden side.



**Gas Cylinders.** Shielding gas cylinders contain gas under high pressure. If damaged, a cylinder can explode. Because gas cylinders usually are part of the welding/cutting process, be sure to treat them carefully. CYLINDERS can explode if damaged.

- Protect gas cylinders from excessive heat, mechanical shocks, physical damage, slag, open flames, sparks, and arcs.
- Ensure cylinders are held secure and upright to prevent tipping or falling over.
- Never allow the welding/cutting electrode or earth clamp to touch the gas cylinder, do not drape welding cables over the cylinder.
- Never weld/cut on a pressurised gas cylinder, it will explode and kill you.
- Open the cylinder valve slowly and turn your face away from the cylinder outlet valve and gas regulator.



**Gas build-up.** The build-up of gas can cause a toxic environment, deplete the oxygen content in the air resulting in death or injury. Many gases used in welding/cutting are invisible and odourless.

- Shut off shielding gas supply when not in use.
- Always ventilate confined spaces or use approved air-supplied respirator.



**Electronic magnetic fields.** MAGNETIC FIELDS can affect Implanted Medical Devices.

- Wearers of Pacemakers and other Implanted Medical Devices should keep away.
- Implanted Medical Device wearers should consult their doctor and the device manufacturer before going near any electric welding, cutting or heating operation.



**Noise can damage hearing.** Noise from some processes or equipment can damage hearing.

- Wear approved ear protection if noise level is high.



**Hot parts.** Items being welded/cut generate and hold high heat and can cause severe burns.

- Do not touch hot parts with bare hands. Allow a cooling period before working on the welding/cutting gun. Use insulated welding gloves and clothing to handle hot parts and prevent burns.

# SAFETY

---

## CAUTION

### 1. Working Environment.

- i. The environment in which this welding/cutting equipment is installed must be free of grinding dust, corrosive chemicals, flammable gas or materials etc., and at no more than a maximum of 80% humidity.
- ii. When using the machine outdoors, protect the machine from direct sunlight, rainwater and snow, etc.; the temperature of the working environment should be maintained within -10°C to +40°C.(14-104F)
- iii. Keep this equipment 30cm/12" distant from the wall.
- iv. Ensure the working environment is well ventilated.

### 2. Safety Tips.

- i. **Ventilation:** This equipment is small-sized, compact in structure, and of excellent performance in amperage output. The fan is used to dissipate heat generated by this equipment during the welding/cutting operation. Important: Maintain good ventilation of the louvres of this equipment. The minimum distance between this equipment and any other objects in or near the working area should be 12 Inches . Good ventilation is of critical importance for the normal performance and service life of this equipment.
- ii. **Thermal Overload Protection:** Should the machine be used to an excessive level, or in a high-temperature environment, poorly ventilated area or if the fan malfunctions the Thermal Overload Switch will be activated, and the machine will cease to operate. Under this circumstance, leave the machine switched on to keep the built-in fan working to bring down the temperature inside the equipment. The machine will be ready for use again when the internal temperature reaches a safe level.
- iii. **Over-Voltage Supply:** Regarding the power supply voltage range of the machine, please refer to the "Main parameter" table. This equipment is of automatic voltage compensation, which enables the maintaining of the voltage range within the given range. In case that the voltage of input power supply amperage exceeds the stipulated value, it is possible to cause damage to the components of this equipment. Please ensure your primary power supply is correct.
- iv. Do not come into contact with the output terminals while the machine is in operation. An electric shock may occur.

## MAINTENANCE

Exposure to extremely dusty, damp, or corrosive air is damaging to the welding/cutting machine. To prevent any possible failure or fault of this welding/cutting equipment, clean the dust at regular intervals with clean and dry compressed air of required pressure.

**Please note that:** lack of maintenance can result in the cancellation of the guarantee; the guarantee of this welding/cutting equipment will be void if the machine has been modified, attempt to take apart the machine or open the factory-made sealing of the machine without the consent of an authorized representative of the manufacturer.

## TROUBLESHOOTING

**Caution:** Only qualified technicians are authorized to undertake the repair of this welding/cutting equipment. For your safety and to avoid Electrical Shock, please observe all safety notes and precautions detailed in this manual.

**DO NOT OPERATE YOUR PLASMA MACHINE ON  
AN EXTENSION LEAD!**

## RAZORCUT 40 PLASMA CUTTER WITH COMPRESSOR

**3 YEAR  
PRODUCT  
WARRANTY**

### Key Features:

- Built-in Air Compressor
- External and Internal Compressor capability
- Pilot Arc Start
- 3/8" Clean Cut
- 1/2" Severance
- CNC Port
- Perforated Cutting Option
- Test Air button
- Portable
- CSA/CAN Approved



**SKU:RC40PCi**

### TECHNICAL DATA

SKU :RC40PCi	
PRIMARY INPUT VOLTAGE	230V Single Phase
RATED INPUT CURRENT	33A
RATED INPUT POWER (kVA)	7.2
RATED OUTPUT VOLTAGE (V)	96
NO LOAD VOLTAGE (V)	210
AIR FLOW DRAW OFF (L/min)	120 L/min/4.25 CFM
AIR FLOW PRESSURE (Bar)	5.17 (75 psi)
PROTECTION CLASS	IP21
INSULATION CLASS	H
MINIMUM GENERATOR (kVA)	10.0
DINSE CONNECTOR	10/25
STANDARD	CSA
WARRANTY (Years)	3

### PLASMA CUT SPECIFICATIONS

	INTERNAL AIR	EXTERNAL AIR
PLASMA CUT CURRENT RANGE	20-40A	20-40A
PLASMA CUT DUTY CYCLE @ 40°C	25% @ 40A	25% @ 40A
	60% @ 26A	60% @ 26A
	100% @ 20A	100% @ 20A
MILD STEEL CUT THICKNESS	10mm/ 3/8"	16mm/5/8"
MILD STEEL SEVERANCE THICKNESS	12mm/ 1/2"	20mm/13/16"
ALUMINIUM CUT THICKNESS	6mm/1/4"	10mm/3/8"
ALUMINIUM SEVERANCE THICKNESS	8mm/5/16"	12mm/1/2"
STAINLESS STEEL CUT THICKNESS	6mm/1/4"	10mm/3/8"
STAINLESS STEEL SEVERANCE THICKNESS	8mm/5/16"	12mm/1/2"

### SIZE & WEIGHT

DIMENSIONS (mm)	610x215x420mm/24"x8.5"x16.5"
WEIGHT (kg)	18.0kg/40 Pounds

### MACHINE FEATURES

PLASMA ARC START	Pilot Arc
THERMAL OVERLOAD PROTECTION	Over Temperature Warning

## Recommended Accessories



**Plasma Cutter Air Filter**  
RF50500F



**RWX1000  
GOGGLE**

**2 YEAR  
PRODUCT  
WARRANTY**



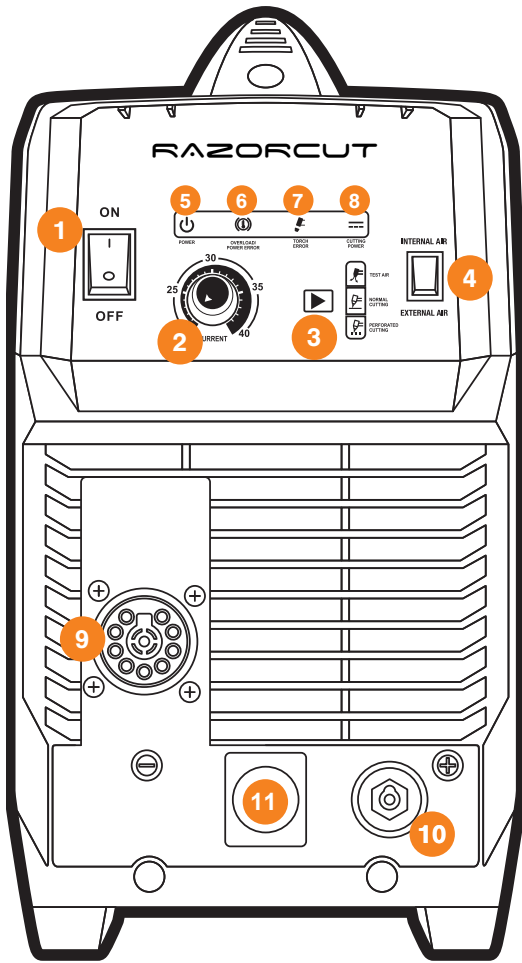

## Front Panel Layout

1. On/Off Power Switch
2. Current Control Knob
3. Cut Mode Switch
4. Internal/External Air Switch
5. Power LED
6. Overload/Power Error LED
7. Torch Error LED
8. Cutting Power LED
9. Plasma Torch Connection
10. Earth Clamp Connection (10/25 Dinse)
11. CNC Port (14 Pin)

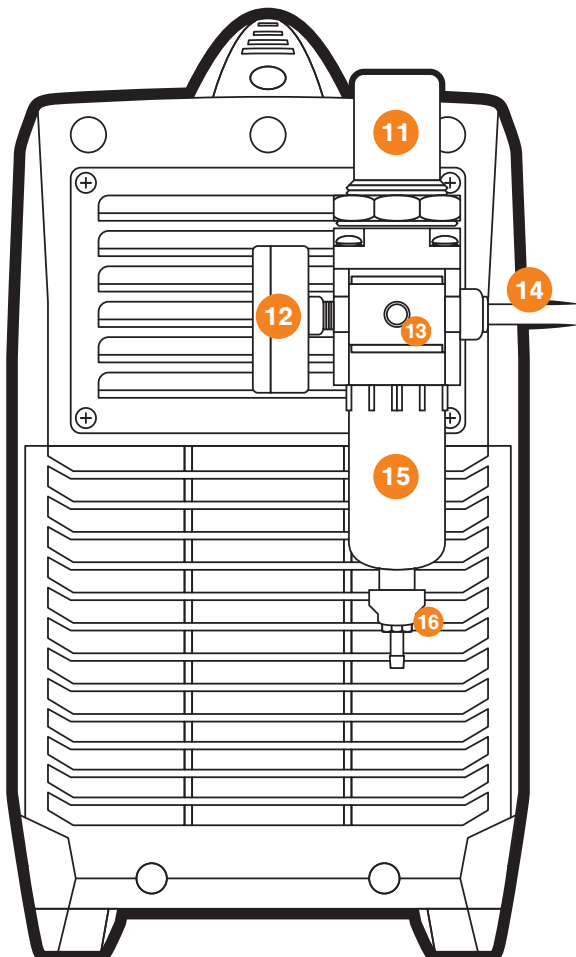

## Rear Panel Layout

11. Air Pressure Regulator Knob
12. Air Pressure Regulator Outlet Pressure Gauge
13. Compressed Air Inlet / Gas Inlet Connector
14. Mains Power Cable
15. Air Condensate Filter / Trap
16. Air Condensate Filter Drain Tube

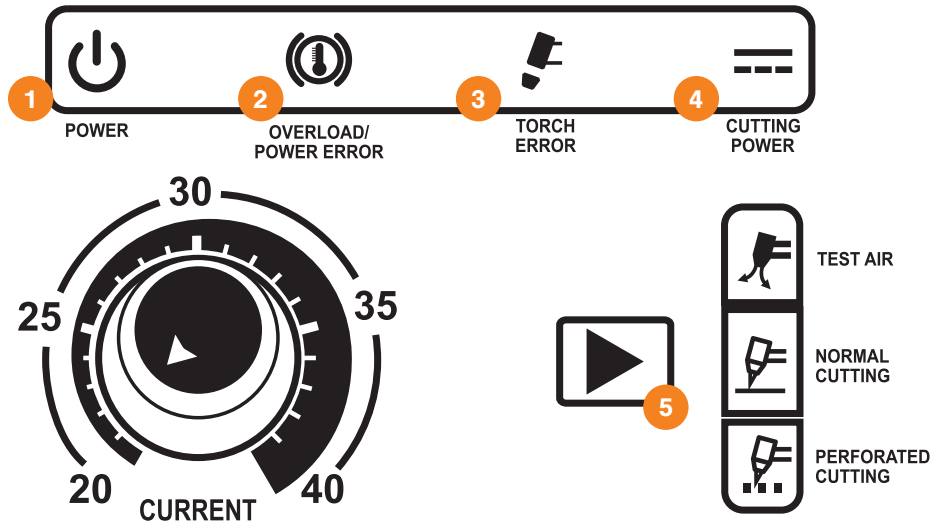

## Additional Machine Control Information

### 1. Power LED

- Lights up when input power connected and the machine switched on.

### 2. Overload / Power Error LED

- Lights up when over-voltage, over-current or electrical overheating (due to exceeding duty cycle) is detected and protection is activated. When protection is activated, cutting output will be disabled until the safety system senses the overload has reduced sufficiently, and the indicator LED goes out. May also trigger if the machine experiences an internal power circuit failure.

### 3. Torch Error LED

- Lights up when an issue with the torch system or air supply detected and cutting output is disabled as a result. Flashing light means that the torch shield cap is not installed. Continuous light means likely damaged or missing torch consumables or insufficient air pressure supply to the torch.

### 4. Cutting Power LED

- Lights up when cutting power circuit activated.

### 5. Cut Mode Switch

- When positioned as “**Test Air**”, the compressed air control valve is open continuously. This is useful for testing and setting the air pressure without having to activate the trigger circuit.
- “**Normal Cutting**” is the standard cutting mode, for use with solid workpieces.
- “**Perforated Cutting**” is the cutting mode when cutting a perforated workpiece.



# WHAT'S IN THE BOX

---

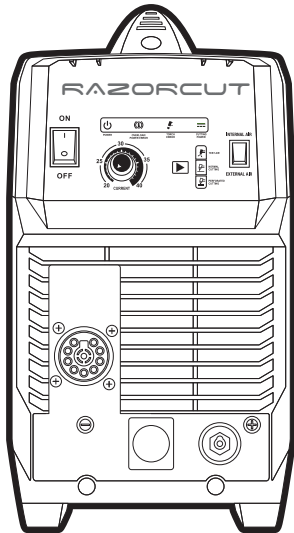

**RAZOR CUT 40 AIR Plasma Cutter**

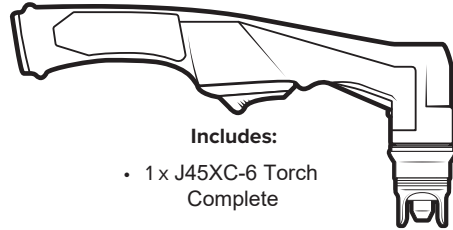

**Includes:**

- 1 x J45XC-6 Torch Complete

**19.5Ft J45XC Plasma Torch**

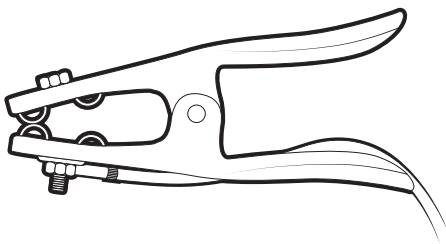

**10ft 200 AMP Earth Clamp**

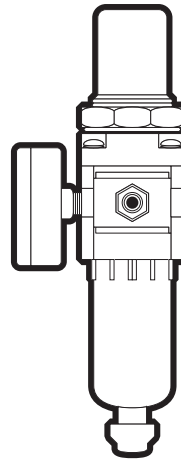

**Air Regulator**

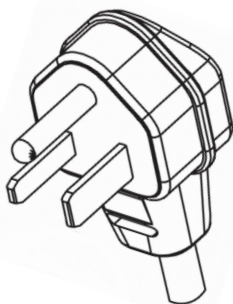

**Plug (Fitted)**

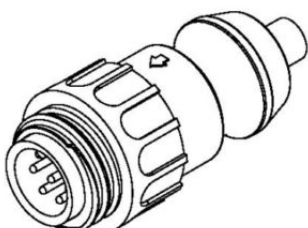

**CNC Plug  
(14 Pin)**



**Operating Manual**

## Additional Machine Control Information

### Compressed Air Requirements

A reliable and consistent supply of clean, dry compressed air is essential for proper operation. Although the machine contains its own internal air supply filtration system it is recommended the compressed air supply should have external filtration in the line feeding the machine, both a standard water trap (sintered bronze filter) and also a coalescing filter (for oil in the air). The air requirement is a minimum of 120 L/min (4.5cfm) Free Air Delivery (FAD) at 75psi pressure. This usually means the compressor must be a belt-drive model or if a direct drive, it must have a motor power of 2.5HP or higher.

The air must be dry and free of oil and moisture (usually a symptom of older, worn-out compressors). The air hose must also be of sufficient size (3/8"/10mm minimum) to supply the machine.

### Operation environment

- Height above sea level  $\leq 1000$  M/3200Ft
- Operation temperature range -10 to +40°C(14-104F)
- Air relative humidity is below 90 % ( 20°C/68F)
- Preferably sit the machine some angles above the floor level, the maximum angle does not exceed 15°
- Protect the machine against heavy rain AND against direct sunshine.
- The content of dust, acid, corrosive gas in the surrounding air or substance cannot exceed the normal standard.
- Take care that there is sufficient ventilation during plasma cutting. There must be at least 30cm free distance between the machine and wall.

### Operation Notices

- Read this manual carefully before starting to use this equipment.
- Connect the ground wire with the machine directly.
- Ensure that the input is single-phase: 50/60Hz, 230V  $\pm 10\%$ .
- Before operation, clear all unnecessary personal from the work area.
- Do not watch the arc in unprotected eyes.
- Ensure proper ventilation of the machine to improve the Duty Cycle.
- Turn off the machine when the operation finished for energy consumption efficiency.
- When the power switch shuts off protectively because of failure, don't restart it until the problem is resolved. Otherwise, the range of the problem will be extended.
- In case of problems, contact your local dealer if no authorized maintenance staff is available

**DO NOT OPERATE YOUR PLASMA  
MACHINE ON AN EXTENSION LEAD**



# SETUP FOR INTERNAL AIR PLASMA CUTTING

- 1 Connect the plasma torch to the plasma torch connection. Tighten the nut once connected to ensure a secure connection.

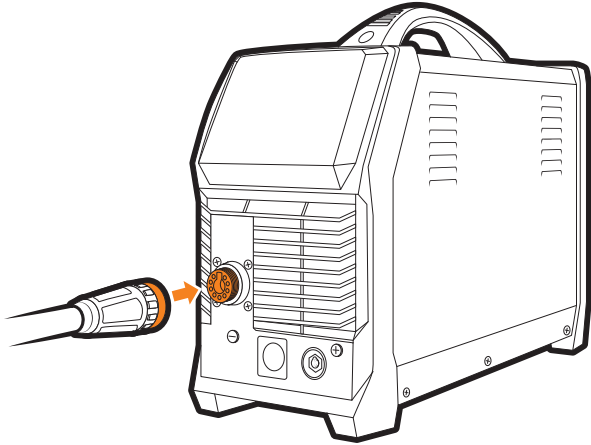

- 2 Connect the earth clamp to the **positive (+)** dinse connection, twist to lock in place

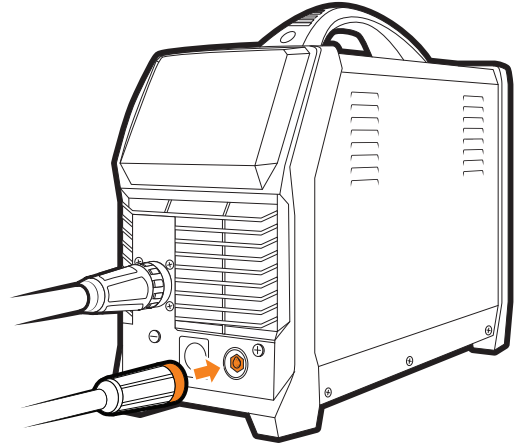

- 3 Connect the plug into the socket, then switch the machine ON.

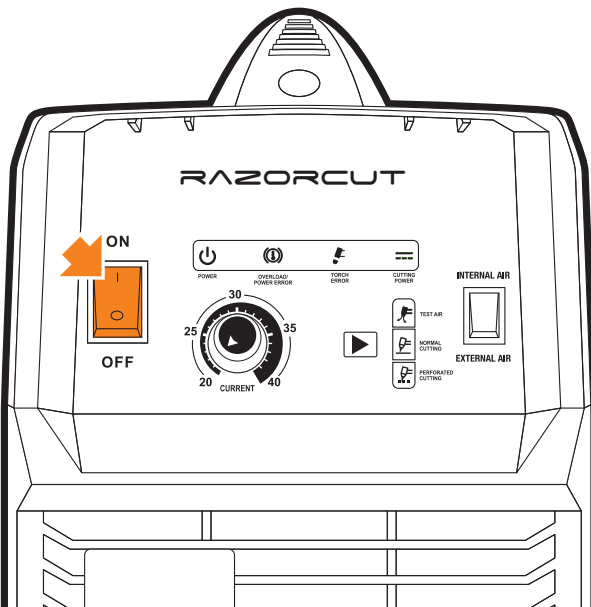

- 4 Select **INTERNAL** air supply.

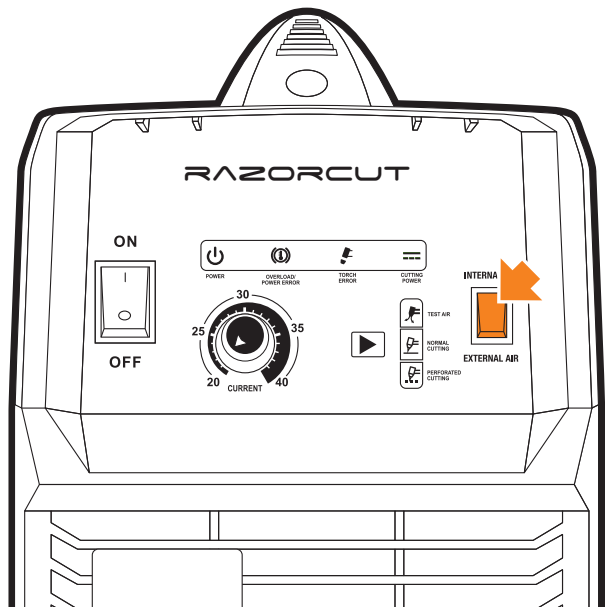

# SETUP FOR INTERNAL AIR PLASMA CUTTING

- 5 Select **Test Air** by pressing the **Cut Mode Mode** button until the Test Air icon lights up, to check that air is feeding correctly.

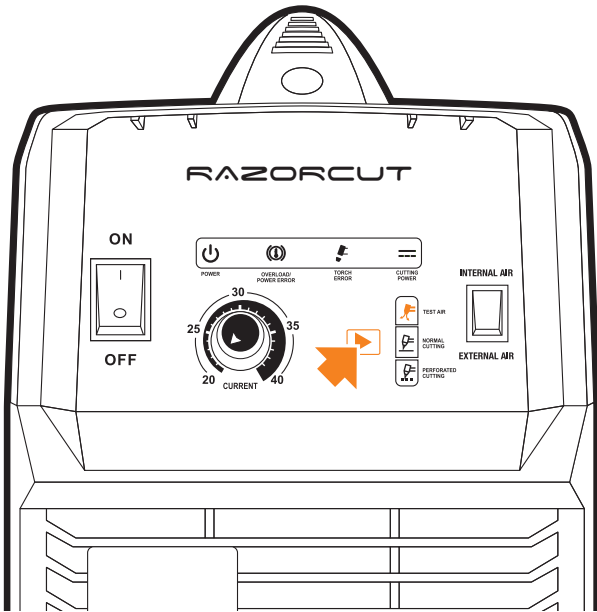

- 6 Connect the earth clamp to the work piece.

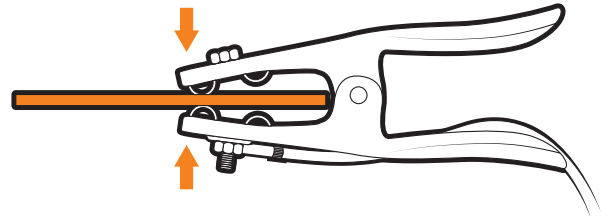

- 7 Select desired cutting mode by pressing the **Cut Mode Mode** button until the desired cutting mode up.

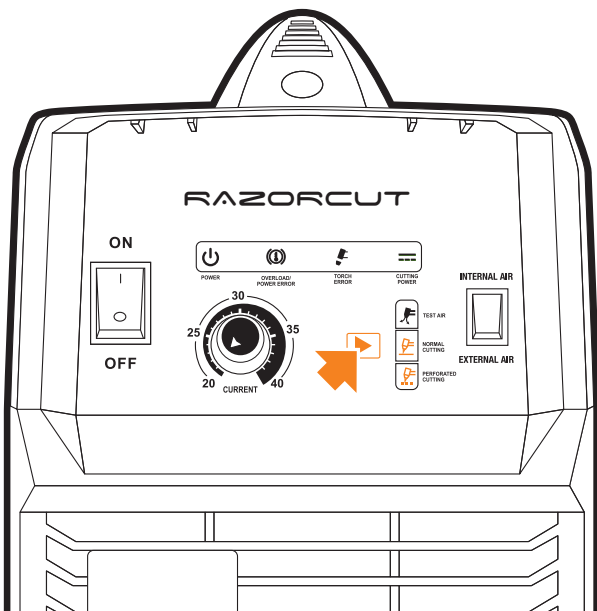

- 8 Set the current to turning the **Current Control Knob**.

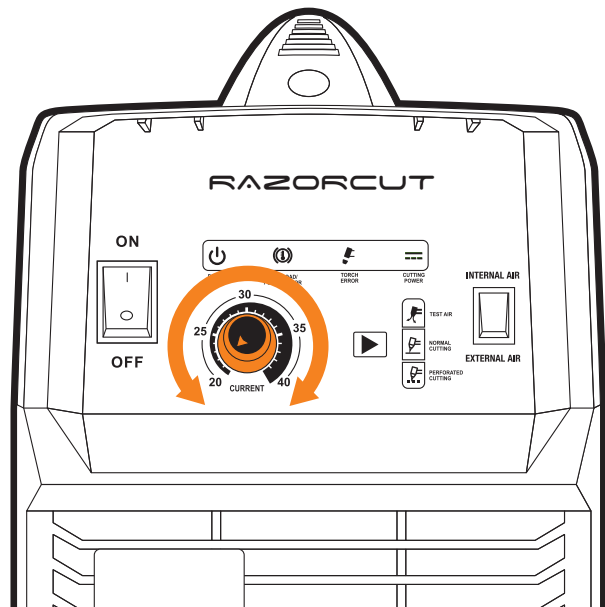



# SETUP FOR INTERNAL AIR PLASMA CUTTING

- 9** Place and hold the torch vertical at the edge of the plate.

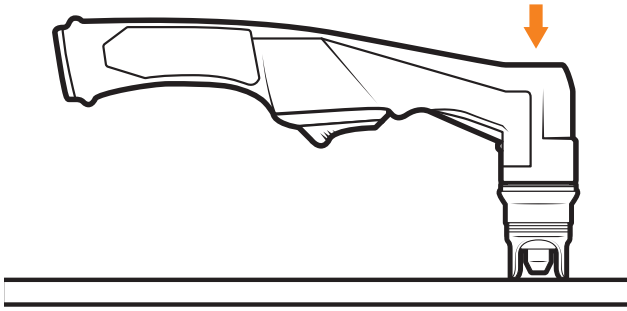

- 10** Pull the trigger to energise the arc. When the cutting arc has cut through the edge of the plate start moving evenly in the direction you wish to cut.

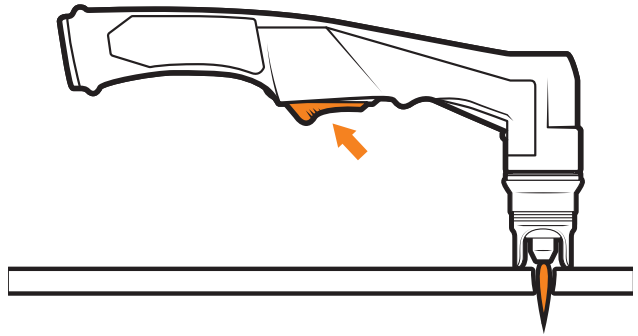

- 11** To finish the cutting release the torch switch. The air flow will continue for 30 seconds to cool the torch head. Do not disconnect air until this cooling period has been completed. Failure to do this will result in torch head damage.

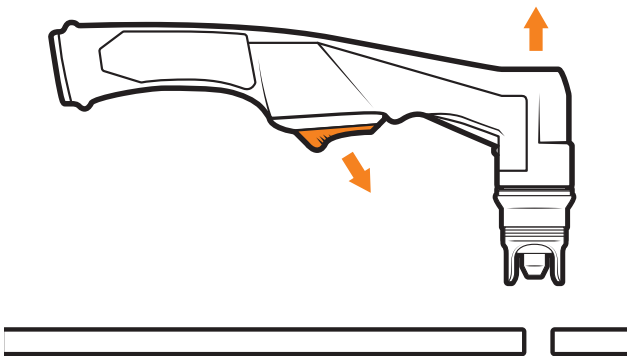

PLEASE NOTE TORCH ILLUSTRATION MAY DIFFER  
DEPENDING ON MODEL

# SETUP FOR EXTERNAL AIR PLASMA CUTTING

- 1 Connect the plasma torch to the plasma torch connection. Tighten the nut once connected to ensure a secure connection.

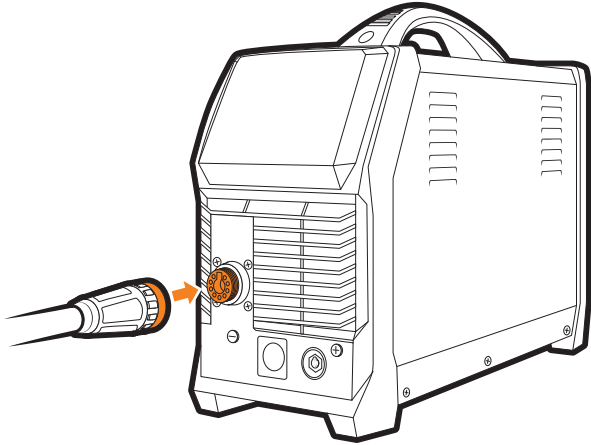

- 2 Connect the earth clamp to the **positive (+)** dinse connection, twist to lock in place

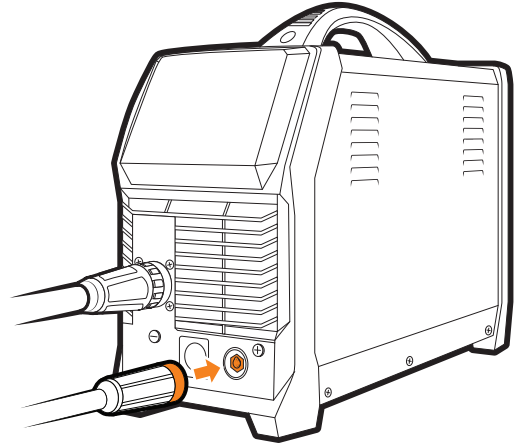

- 3 Connect the plug into a 230v Power socket, then switch the machine ON.

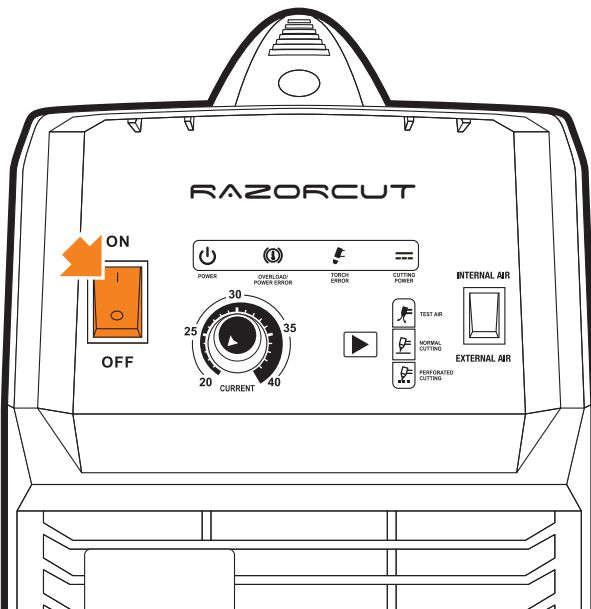

- 4 Select **EXTERNAL** air supply.

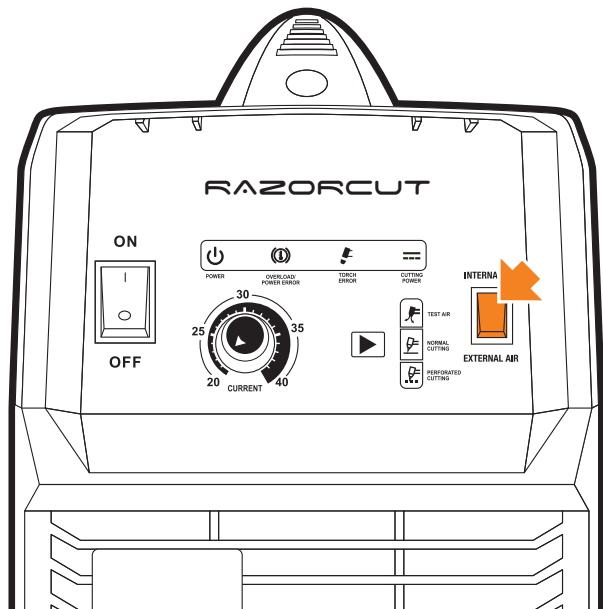

**WARNING: USE COMPRESSED AIR ONLY WITH THIS MACHINE**

# SETUP FOR EXTERNAL AIR PLASMA CUTTING

- 5 Connect air supply to the Air Filter.

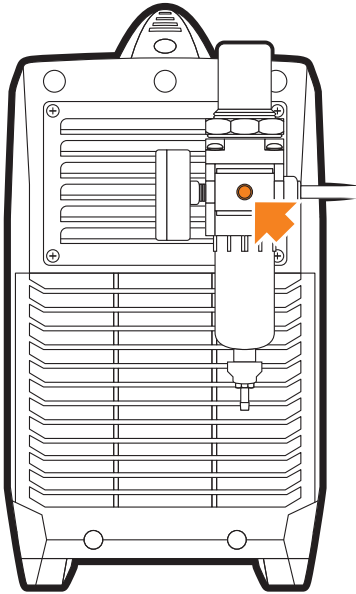

- 6 Select **Test Air** by pressing the **Cut Mode Mode** button until the Test Air icon lights up.

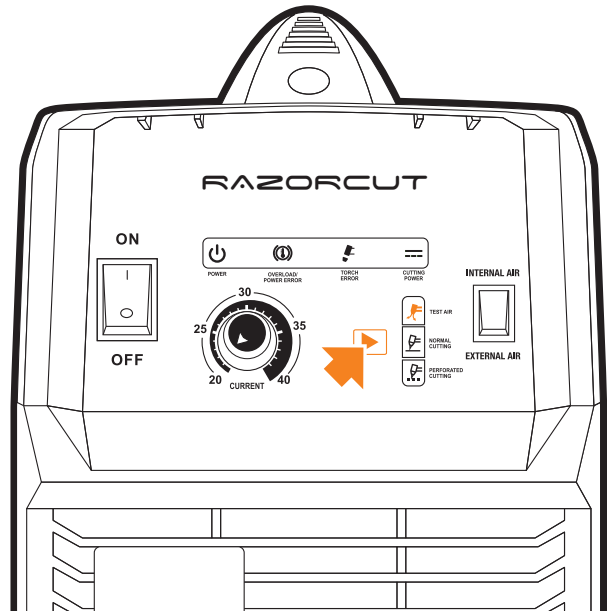

- 7 Lift the **Air Pressure Regulator Knob**, then turn the knob until you reach an ideal reading of 0.5MPa (75psi).

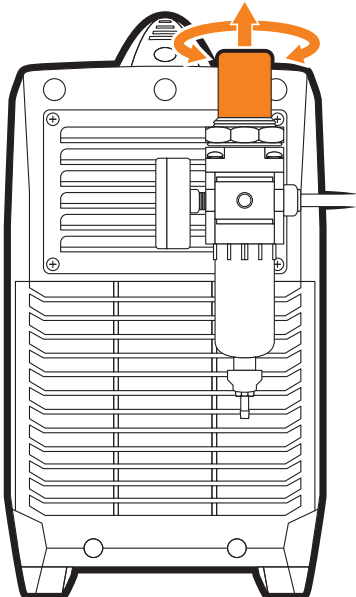

- 8 Push the **Air Pressure Regulator Knob** downwards to lock the reading in place.

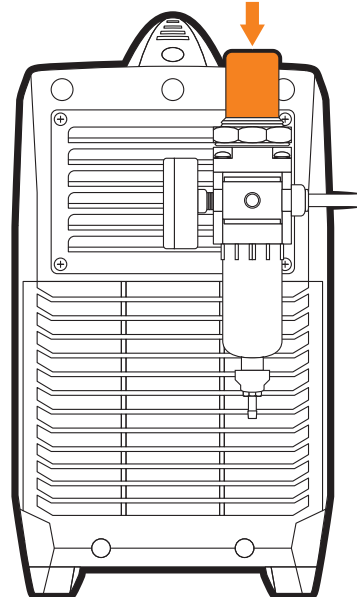

# SETUP FOR EXTERNAL AIR PLASMA CUTTING

- 9 Connect the earth clamp to the work piece.

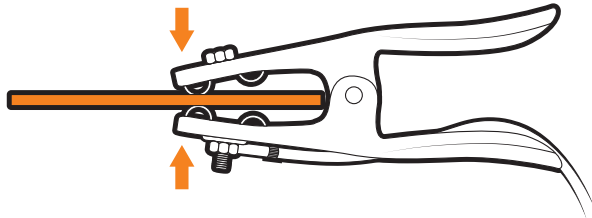

- 10 Select desired cutting mode by pressing the **Cut Mode** button until the desired cutting mode up.

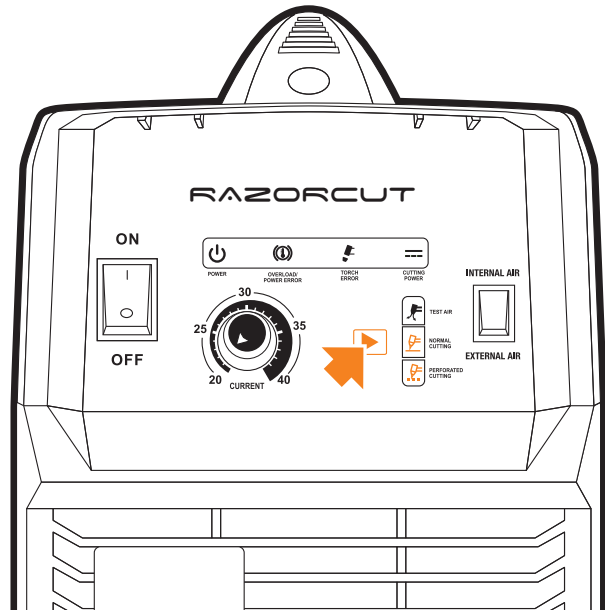

- 11 Set the current to turning the **Current Control Knob**.

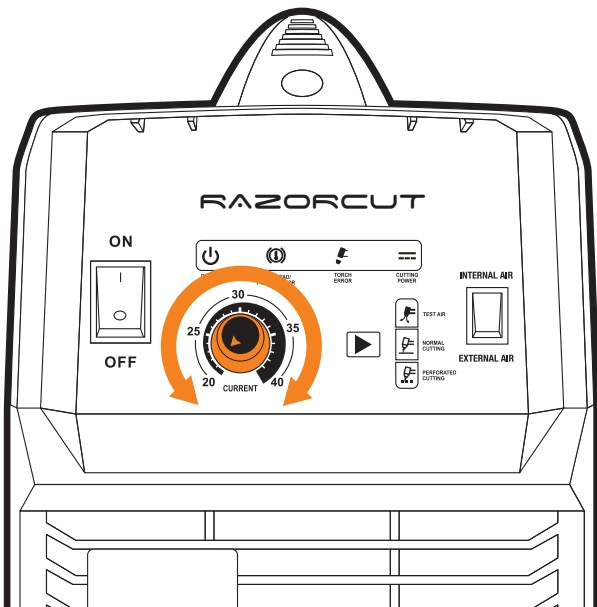

- 12 Place and hold the torch vertical at the edge of the plate.

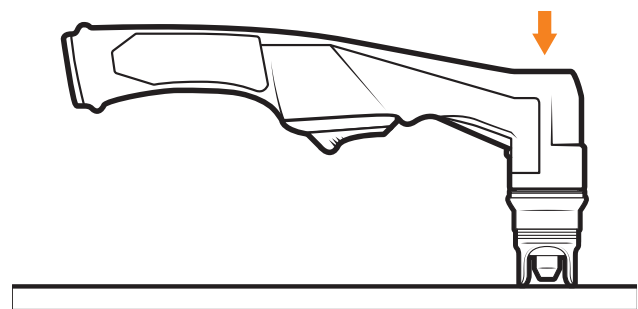



# SETUP FOR EXTERNAL AIR PLASMA CUTTING

- 13** Pull the trigger to energise the arc. When the cutting arc has cut through the edge of the plate start moving evenly in the direction you wish to cut.

- 14** To finish the cutting release the torch switch. The air flow will continue for 30 seconds to cool the torch head. Do not disconnect air until this cooling period has been completed. Failure to do this will result in torch head damage.

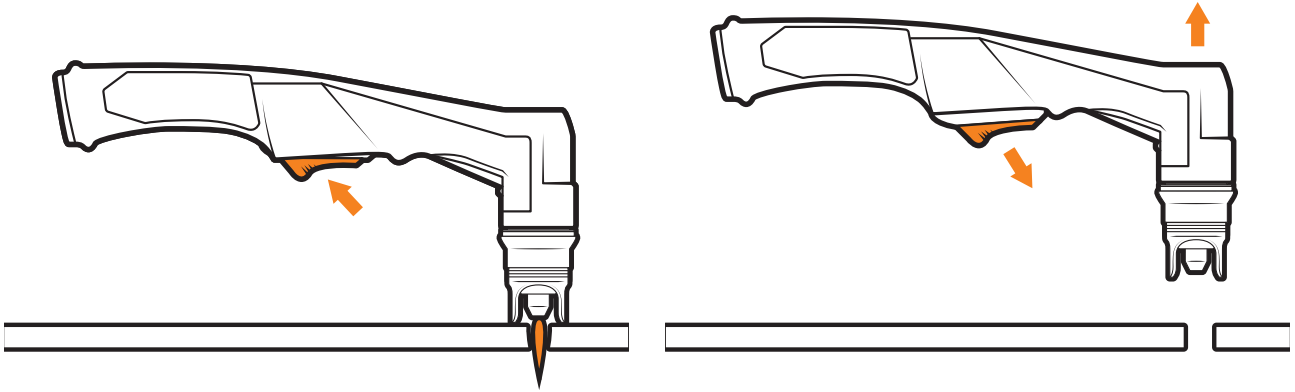

## NOTES FOR USING THE MACHINE FOR CNC CUTTING

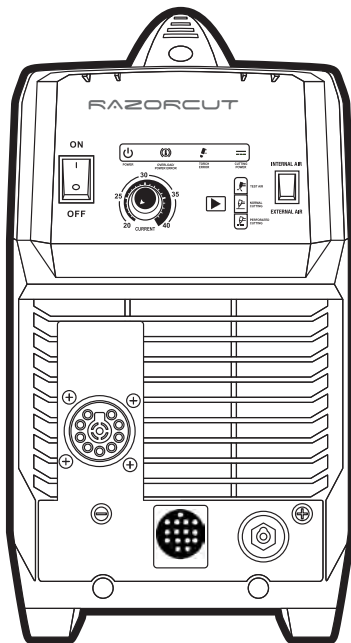

Your RAZORCUT 40PCi is fitted with a CNC Port with 12 female pins. Your machine is supplied with a male 12 pin connector. Please consult your CNC Machine manufacturer for specific software requirements.



Please note the below:

\*Pin 6+7 is the 50:1 voltage divider (Pin 6 is positive (+) and pin 7 is Negative (-))

\*Pin 8 +9 are the Trigger pins

An appropriate wiring diagram can be found in with the Male external plug as part of the machine package.

**PLEASE NOTE: DO NOT RUN YOUR MACHINE OFF AN EXTENSION LEAD AND ALSO ONLY OPERATE THE MACHINE WHEN CNC CUTTING USING AN EXTERNAL AIR COMPRESSOR!**

# PLASMA CUTTING TECHNOLOGY

Plasma cutters work by passing an electric arc through a gas that is passing through a constricted opening. The electric arc elevates the temperature of the gas to the point that it enters a 4th state of matter. We all are familiar with the first three: i.e., Solid, liquid, and gas. Scientists call this additional state plasma. As the metal being cut is part of the circuit, the electrical conductivity of the plasma causes the arc to transfer to the work. The restricted opening (Tip) the gas passes through causes it to squeeze by at high speed, like air passing through a venturi in a carburettor. This high-speed gas cuts through the molten metal. Plasma cutting was invented as a result of trying to develop a better welding process. Many improvements then led to making this technology what it is today. Plasma cutters provide the best combination of accuracy, speed, and affordability for producing a variety of flat metal shapes. They can cut much finer and faster than oxy-acetylene torches.

## How a plasma cutter works:

Basic plasma cutters use electricity to superheat air into plasma (the 4th state of matter), which is then blown through the metal to be cut. Plasma cutters require a compressed air supply and AC power to operate.

### Operation:

1. When the trigger is squeezed, DC current flows through the torch lead into the tip.
2. Next, compressed air flows through the torch head, through the air diffuser that spirals the airflow around the electrode and through the hole of the cutting tip.
3. A fixed gap is established between the electrode and the tip. (The power supply increases voltage in order to maintain a constant current through the joint.) Electrons arc across the gap, ionizing and superheating the air creating a plasma stream.
4. Finally, the regulated DC current is switched so that it no longer flows to the tip but instead flows from the electrode to the workpiece. Current and airflow continue until cutting is stopped.

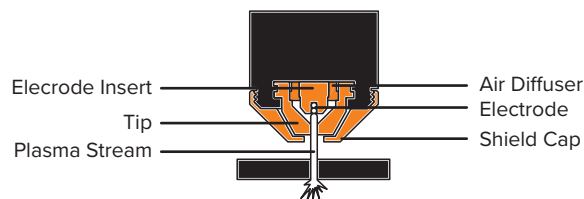

The nozzle and electrode require periodic replacement. The electrode has an insert of a tough high conductive material such as hafnium and cerium. This insert erodes with use; also, the tip orifice will erode with use. Quality of the air used is paramount to longer life of electrodes and tips, in short, clean dry air gives more extended parts life, the cleaner and dryer the better. We recommend the use of a Plasma Air Filter.

### What kinds of materials can the plasma cut?

Virtually any metal can be plasma cut including steel, stainless steel, aluminum, brass, copper, etc. Any thickness from 30 gauge through 11/4" can be cut, depending on the power of the plasma cutter used.

### How Does Plasma Cutting Compare to Oxy-fuel (gas) cutting?

Plasma cutting can be performed on any conductive metal - mild steel, aluminum and stainless are some examples. With mild steel, operators will experience faster, thicker cuts than with alloys.

Oxy-fuel cuts by burning, or oxidizing the metal it is cutting. It is therefore limited to steel and other ferrous metals which support the oxidizing process. Metals like aluminum and stainless steel form an oxide that inhibits further oxidization, making conventional oxy-fuel cutting impossible. Plasma cutting, however, does not rely on oxidation to work and thus it can cut aluminum, stainless and any other conductive material. While different gases can be used for plasma cutting, most people today use compressed air for the plasma gas. In most shops, compressed air is readily available, and thus plasma does not require fuel gas and compressed oxygen for operation.

Plasma cutting is typically more accessible for the novice to master, and on thinner materials, plasma cutting is much faster than oxy-fuel cutting. However, for heavy sections of steel (1" and greater), oxy-fuel is still preferred since oxy-fuel is typically faster and, for heavier plate applications, high powered plasma machines are required for plasma cutting applications.

### What are the limitations to Plasma Cutting? Where is Oxy-fuel preferred?

The plasma cutting machines are typically more expensive than oxy/acetylene. Also, oxy/acetylene does not require access to electrical power or compressed air which may make it a more convenient method for some users. Oxy-fuel can generally cut thicker sections (>1") of steel more quickly than plasma.

# PLASMA CUTTING TIPS & TECHNIQUES

## Amperage

The standard rule of thumb is the thicker the material, the more amperage required. On thick material, set the machine to full output and vary your travel speed. On thinner material, you need to turn down the amperage and change to a lower-amperage tip to maintain a narrow kerf. The kerf is the width of the cut material that is removed during cutting.

## Speed

Amperage and speed are critical to producing a good quality cut. The faster you move (especially on aluminium), the cleaner your cut will be. To determine if you're going too fast or too slow, visually follow the arc that is coming from the bottom of the cut. The arc should exit the material at a slight angle away from the direction of travel. If it's going straight down, that means you're going too slow, and you'll have an unnecessary build-up of dross or slag. If you go too fast, it will start spraying back onto the surface of the material without cutting all the way through. Because the arc trails at an angle, at the end of a cut, slow your cutting speed and angle the torch in to cut through the last bit of metal.

## Direction

It is easier to pull the torch towards you than push it. The plasma stream swirls as it exits the tip, biting one side and finishing off on the other, leaving a bevelled edge and a straight edge. The bevel cut effect is more noticeable on thicker material and needs to be taken into consideration before starting your cut as you want the straight side of the cut to be on the finished piece you keep.

## Torch tip height & position

The distance and position of the plasma torch cutting tip affect the quality of the cut and the extent of the bevel of the cut. The easiest way to reduce bevel is by cutting at the proper speed and height for the material and amperage that is being cut.

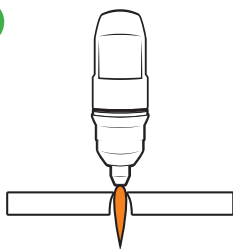

Correct torch height and square to the material. Minimum bevel & equal bevel. Longest consumable life. The J45XC Torch has a standoff guide as part of the end consumable configuration so is designed for you to rest your end piece on the work for cutting

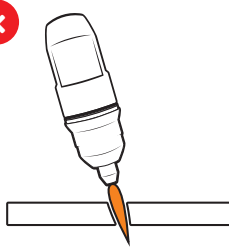

Torch angled to the material. Unequal bevel, one side may be excessively bevelled.

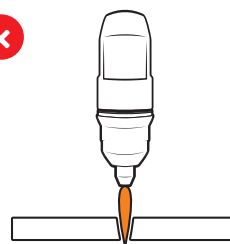

Torch height too high. Excessive bevel, plasma stream may not cut all the way through the material.

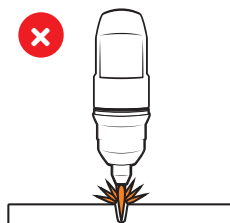

If sparks are spraying up from the work piece, you are moving the torch too fast, or you don't have enough amps set.

## Tip size and condition

The tip orifices focus the plasma stream to the workpiece. It is essential to use the correct size tip for the amperage being used, for example, a tip with a 1.0mm/3/64" orifice is suitable for 0-40 amps whereas a 1.3mm 0.051" orifice is better for 40-80 amps. The low-amp tip has a smaller orifice which maintains a narrow plasma stream at lower settings for use on thin-gauge material. Using a 25 amp tip at a 60 amp setting will blow out and distort the tip orifice and require replacement. Conversely, using an 80-amp tip on the lower settings will not allow you to focus the plasma stream as well and creates a wide kerf. The condition of the tip orifice is critical to the quality of the cut result, a worn or damaged tip orifice will produce a distorted plasma stream resulting in poor cut quality.

## Electrode condition

A fixed gap is established between the electrode and the inside of the cutting tip — electrons arc across the gap, ionizing and superheating the air creating the plasma stream. The electrode contains an insert at the end made of a highly conductive material called hafnium. This insert erodes with use and develops a pit at the end of the electrode when the pit becomes too much poor-quality cuts will result and necessitate replacement of the electrode.

## Air pressure and volume

Air pressure, flow rate and air quality are critical to quality plasma cutting and consumable life span. The required air pressure and volume can vary from model to model, and the manufacturer will provide the specs.

The RAZORCUT 40 AIR air pressure must be adjusted and set to 0.5MPA (75psi) and requires a flow rate of 120 L/min. The volume capacity of your compressor is important. If you have a small compressor with precisely the same L/min rating as the plasma, then the compressor will run continuously when you are plasma cutting. A compressor with a L/min rating slightly higher than the plasma would be more than adequate. If you are doing a lot of cutting, cutting thick plate (same air consumption but slower cut speeds = longer cut time), then choose a compressor at 1.5 to 2 times the plasma system requirement.

## Air quality

Good, dry air is essential to quality plasma cutting and consumable life span.

Compressors take in air at atmospheric pressure and increase the pressure and store it in a tank. Humidity in the air is condensed in the tank and the airlines producing water, more so in humid environments. Moisture that forms in airlines tends to condense into larger drops when the air pressure decreases as it is entering the plasma torch. When these droplets enter into the high temperatures (as much as 11,000°C) in the plenum of the torch, they immediately break down into oxygen and hydrogen, which alters the regular chemical content of the air in the torch. These elements will then dramatically change the plasma arc which causes the torch consumable parts to wear very quickly, alters the shape of the nozzle orifice, dramatically affecting cut quality in terms of edge squareness, dross formation, and edge smoothness. Water will also damage your Plasma head

Minimizing the moisture in the air supply is absolutely critical to quality plasma cuts and longevity of consumable parts. As a minimum be sure to drain the receiver (tank) on the air compressor at least daily.

Most air plasma systems from reputable manufacturers have an onboard particulate filter and or a coalescing filter with an auto drain that will remove some moisture from the air supply. For home workshop and light industrial users, the onboard air filter is adequate. Most situations, however, will require additional filtration to prevent moisture from affecting the quality of the plasma cutter and in most cases, it is recommended to install a submicronic particulate filter that is designed to trap water through absorption. This style of filter has a replaceable filter cartridge that absorbs water and must be changed after it is near saturation; it should be installed close as possible to the air intake of the plasma cutter.

## General Tips

- It is easier to pull the torch through the cut than to push it.
- To cut thin material, reduce the amperage until you get the best quality cut.
- Use the correct size tip orifice for the amperage being used.
- For straight cuts use a straight edge or cutting buggy as a guide. For circles, use a template or circle cutting attachment.
- Check that the front end consumable parts of the plasma cutting torch are in good condition.



### Plasma Cutter Air Filter

SKU: RF50500F

*Most situations, however, will require additional filtration to prevent moisture from affecting the quality of the plasma cutter and in most cases, it is recommended to install a submicronic particulate filter that is designed to trap water through absorption.*





PLASMA

# J45XC

Plasma Cutting Torch

JASIC TECHNOLOGIES AMERICA INC  
25503 74th Ave S, Kent, WA 98032  
Ph: 253-859-6277, Fax: 253-859-6286  
sales@razorweld.com

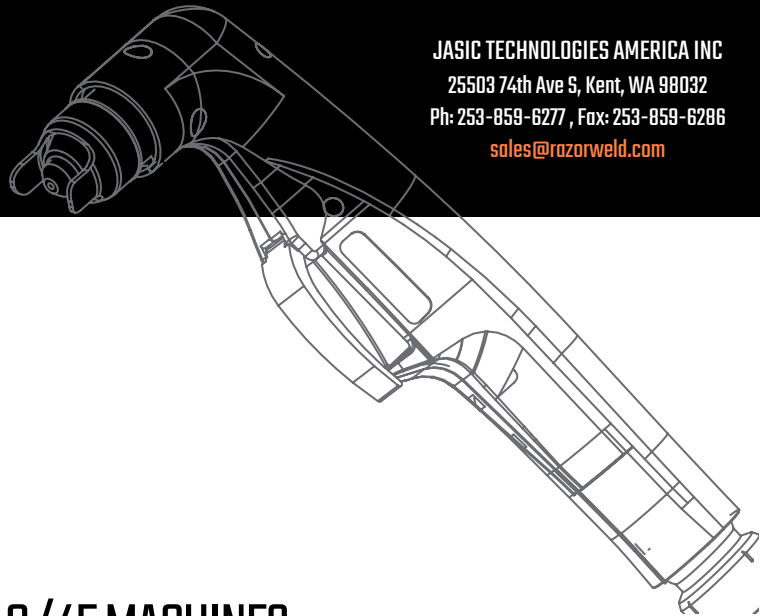

## Technical Data

Current : 45 Amps  
Duty Cycle: 60%@40Amps  
Air pressure: 65-75 psi (4.5 -5.0bar)  
Flow: 3.55cfm (100l/m)  
Ignition: Non H/F

TORCH SUITABLE FOR RAZORCUT 30/40/45 MACHINES

BACK STRIKING



PART	CODE	DESCRIPTION	PACK QTY
1	RW001	J45XC TORCH HEAD	1
2	RWPR1048-03	ELECTRODE	5
3	RW1601	SWIRL RING	1
4	RWPN792-08	CUTTING NOZZLE	5
5	RW0632-05	OUTSIDE NOZZLE	1
6	RW0658	SHIELD CAP	1
7	RW0678	DOUBLE POINTED SPACER	1
8	PLAK06	PLASMA CUTTING KIT	1
9	PLAK07	PLASMA CUTING KIT (ELECTRODES+ NOZZLES)	1
10	RW	HANDLE KIT	1
11	RW0085*	TWIN PRONG STAND OFF GUIDE <small>*FOR USE WITH 7&amp;8 ONLY</small>	1
	J100XC6	PLASMA TORCH 19.5FT CENTRAL ADAPTOR	
	J100XC6M	AUTO PLASMA TORCH 19.5FT CENTRAL ADAPTOR	

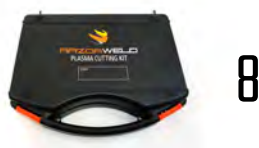

8



9



11

## QUALITY ORIGINAL PARTS

# MACHINE PARTS BREAKDOWN

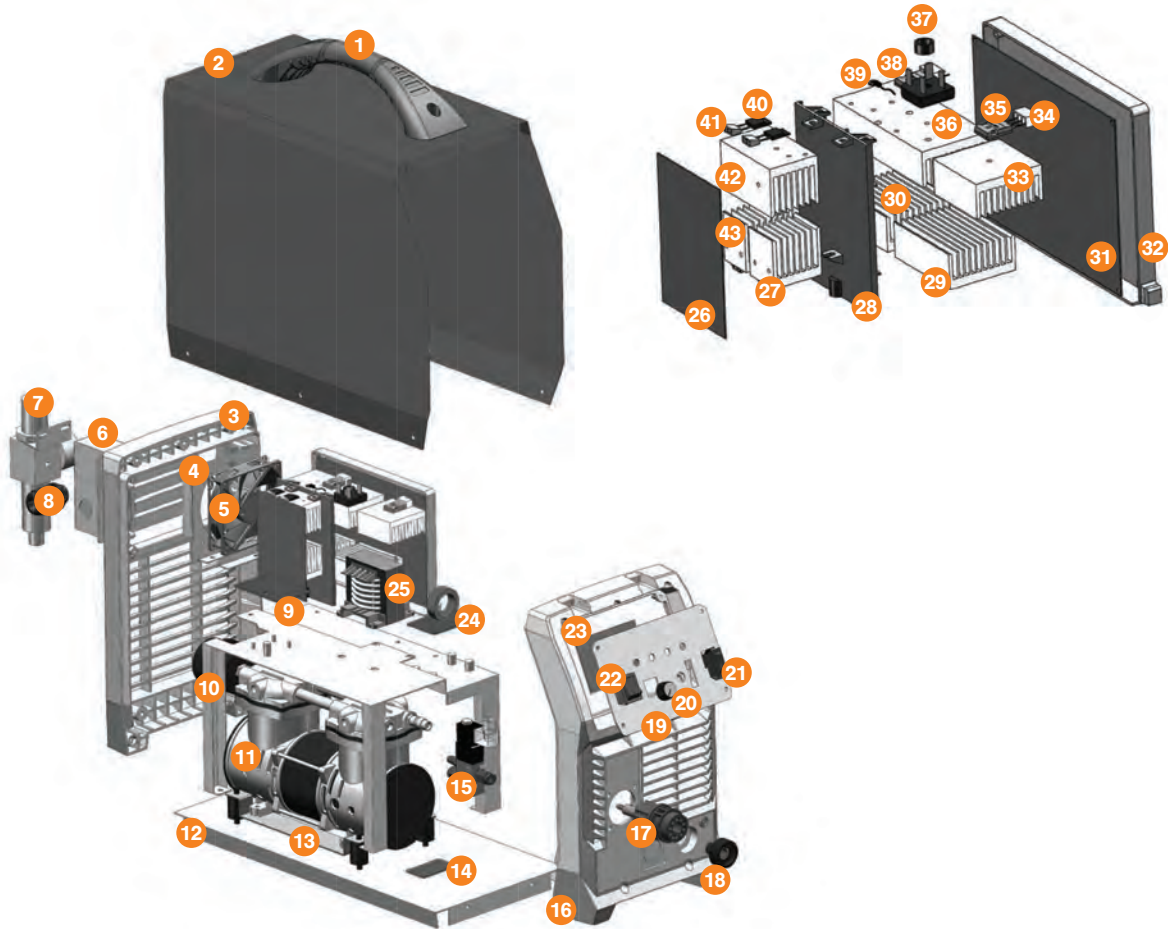

## MACHINE SPARES

1	7.2530.004	Handle
2	7.3010.0705	machine cabinet
3	7.0680.921	rear plastic panel
4	7.1220.0705	fixing plate for fan
5	6.7200.006-A	fan
6	7.3070.0705	fixing sealing plate for rear panel
7	6.2530.201	Oil water separator
8	6.1550.003	fixing clamp for power cable
9	3.0628.7011	EMC PCB
10	7.1230.067	Holder for power block
11	6.7210.001	pump
12	7.0550.0705	bottom plate
13	7.1230.066	fixing plate for pump
14	3.0628.7025	Switch PCB for pump
15	6.2530.101	Two position three-way solenoid valve
16	7.0690.921	front plastic panel
17	6.6670.002	control socket
18	6.1520.001-A	socket
19	7.3060.0705	fixing plate for front control pcb
20	6.4580.001	knob
21	6.2320.201	Switch
22	6.2320.001	Switch

## MACHINE SPARES

23	3.P628.4026-E	Digital display PCB
	3.0628.1038-C	Control PCB
24	3.0628.7003	Inductance output PCB
25	5.1850.0705	main transformer
26	3.0628.6002	FRD PCB
27	7.4230.031	Heat sink for FRD
28	7.7130.907	Middle block plate
29	7.4220.089	heat sink
30	7.4220.088	heat sink
31	3.0628.2004	main PCB
32	7.1230.932	sealing box for main PCB
33	7.4220.087	heat sink
34	7.7130.001	insulation sheet
35	6.4250.004	IGBT
36	7.4220.086	heat sink
37	6.6620.001	Screw cover buckle
38	6.4110.003	rectifier bridge
39	6.2310.002-A	thermo resistor
40	6.4010.001	fast recovery diode
41	7.7130.007	insulation plate
42	7.4230.029	heat sink for FRD
43	7.4230.030	heat sink for FRD

# FAQ & TROUBLESHOOTING

---

**WARNING: There are extremely dangerous voltage and power levels present inside this unit. Do not attempt to diagnose or repair unit by removing external cover unless you are an authorized JASIC repair facility**

## 1. Power lamp and temperature lamp on.

- Airflow blocked, check for blocked airflow around the unit and correct condition.
- Fan blocked, check and correct condition.
- Unit is overheated, let the unit cool down for at least 5 minutes. Make sure the unit has not been operated beyond Duty Cycle limit.
- Faulty components in the unit, return for repair or have qualified technician repair per Service Manual.

## 2. Torch fails to ignite the arc when the torch switch is activated

- The system is in SET mode, change to RUN mode.
- Faulty torch parts, inspect torch parts and replace if necessary.
- Gas pressure too high or too low, adjust to the proper pressure.
- Faulty components in the unit, return for repair or have qualified technician repair per Service Manual.

## 3. No cutting output; Torch activated, power source on; Gas flows; Fan operates

- Torch not correctly connected to the machine, check that torch leads are correctly connected to the machine.
- Work cable not connected to the workpiece, or connection is weak, make sure that work cable has a proper connection to a clean, dry area of the workpiece.
- Faulty components in the unit, return for repair or have qualified technician repair per Service Manual.
- Faulty torch, return for repair or have qualified technician repair.

## 4. Low cutting output

- Incorrect setting of CURRENT (A) control, check and adjust to the proper setting.
- Faulty components in the unit, return for repair or have qualified technician repair.

## 5. Difficult Starting

- Worn torch parts (consumables), shut off input power. Remove and inspect torch shield cup, tip and electrode. Replace electrode or tip if worn; replace shield cup if excessive spatter adheres to it.

## 6. Arc shuts off during operation; arc will not restart when the torch switch is activated.

- Power Supply is overheated, let the unit cool down for at least 5 minutes. Make sure the unit has not been operated beyond Duty Cycle limit. Refer to Section 2 for duty cycle specifications.
- Gas pressure too low, check the source for at least 4bar/60psi; adjust as needed. It is needed to open the machine cover.
- Torch consumables worn, check torch shield cup, tip, starter element, and electrode; replace as needed.
- Faulty components in the unit, return for repair or have qualified technician repair per Service Manual.

## 7. No gas flow; the power lamp on; Fan operates

- Gas not connected or pressure too low, check gas connections. Adjust gas pressure to the proper setting

## 8. Torch cuts but low quality

- Current (A) control set too low, increase the current setting.
- The torch is being moved too fast across the workpiece, reduce cutting speed.
- Excessive oil or moisture in torch, hold torch 1/8 inch (3 mm) from a clean surface while purging and observe oil or moisture build-up (do not activate torch). If there are contaminants in the gas, additional filtering may be needed.





# NOTES

---

---

---

---

---

---

---

---

---

---

---

---

---

---

---

---

---

---

---

---

---

---

---

---

---

---

---

---

---

---

---

---

---

---

A series of horizontal dotted lines for writing notes, spanning the width of the page below the header line.



**JASIC TECHNOLOGIES AMERICA INC**  
25503 74th Ave S, Kent, WA 98032  
Ph: (+1) 253-859-6277 Fax:(+1) 253-859-6286)  
[www.razorweld.com](http://www.razorweld.com)  
[sales@razorweld.com](mailto:sales@razorweld.com)  
"A JASIC GROUP COMPANY"